

(Bad copy)

SQ-10

SERVICE MANUAL

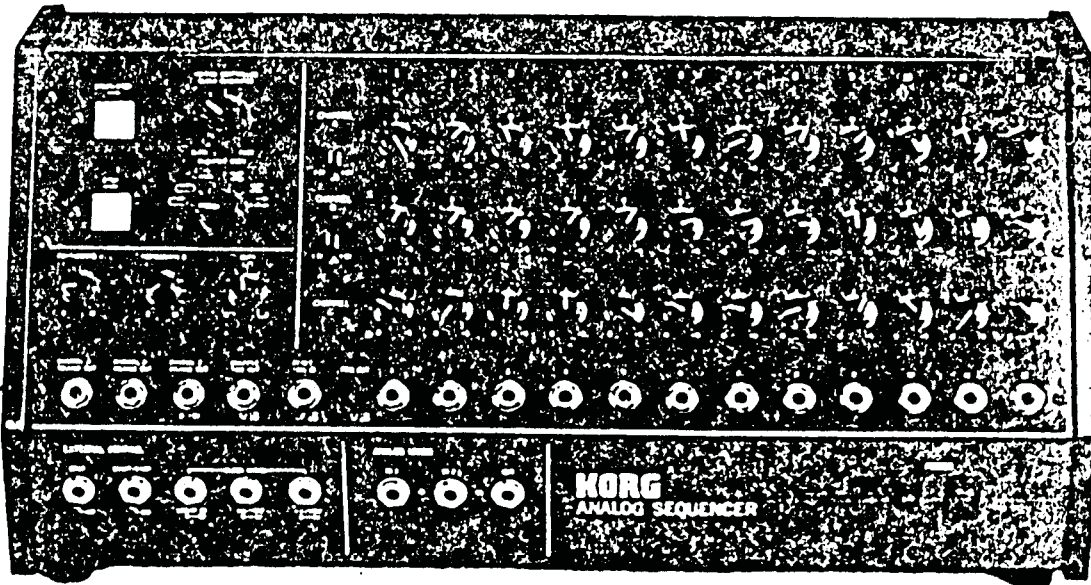

KEIO ELECTRONIC LAB., CORP.
TOKYO, JAPAN

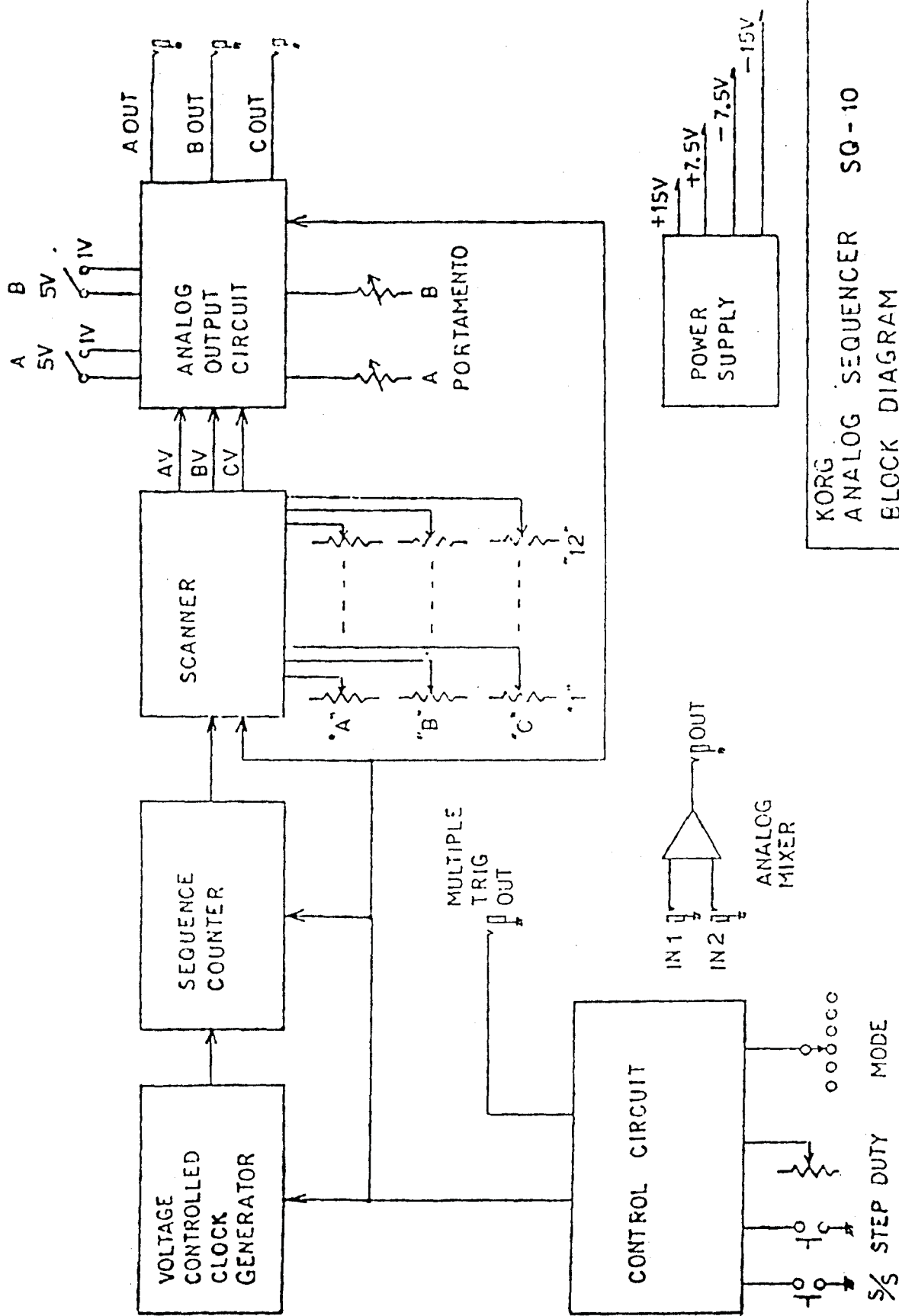

KORG
ANALOG SEQUENCER SQ-10
BLOCK DIAGRAM



Checking and Adjustment

Power Check & Adjust

1. +15V; Should be 14.4V~15.6V.
2. -15V; Should be -14.4V~-15.6V.
3. +7.5V; Adjust VR46 to 7.50V.
4. -7.5V; Adjust VR47 to -7.50V.

Function Test -- Standard -- Connect MS-10 (fig 1)

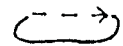
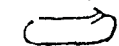
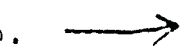
Set MS-10 and SQ-10 controls (fig 2)
(fig-3)

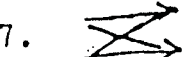

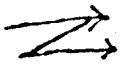
No.	Mode Rotary switch	Check
2.		Clock LED flashes on and off.
3.		'12' LED turns on first. Then 1 and 2 each time step button is pressed, so the sequence goes 12, 1, 2. A and B LED's do not turn on in this mode.
4.		LED's 1 through 12 should be off at first. When S/S switch is pressed, sequence goes 1, 2, ..., 12, 1, 2, ... When S/S switch is pressed again, LED's go out. A and B do not light.
5.		LED's 1 through 12 should be off at first. When you turn on the S/S switch, the sequence should automatically advance 1, 2, ..., 12... and then stop after one time, If you press the S/S switch between 1 and 12, the sequence should stop. A and B do not turn on.
6.		B and 12 are on at first. A and 1 turn on when you first press the Step switch. Press it again for 2...12; again for B 1...12; and again for A 1...
7.		A and B and 1 through 12 should all be off at the beginning. When you press the S/S switch, the sequence should go A 1...12, B 1...12, A 1... automatically. Press the S/S switch again to stop.

8.  At the beginning A and B and 1 through 12 should all be off. Press the S/S switch and there should be a single cycle of A 1...12 and B 1...12. Then it should stop. It should also stop if you press the S/S switch while the LED's are changing.

Function Test (2)

- means the phone plug connected to the MS-10 CV IN.
- ⊗ means the phone plug connected to the opposite side (open).

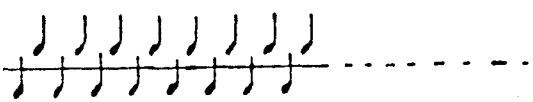
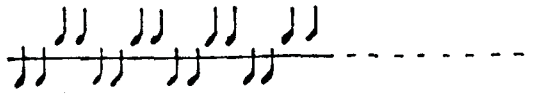
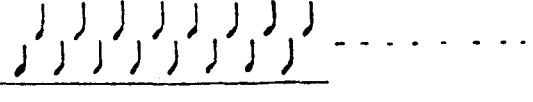
sa-10 Check 2/4

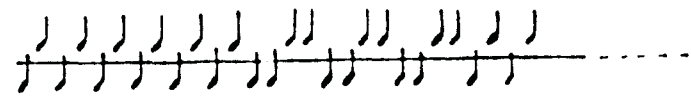
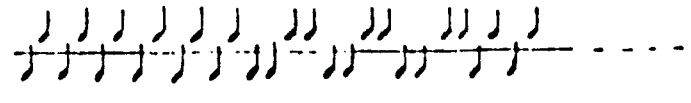
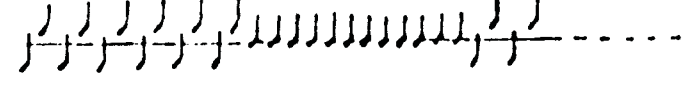
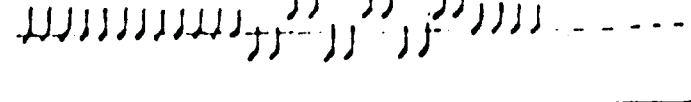

NO	MODE Rotary SW	(OUTPUT)			Musical interval
		A	B	C	
9		○			
10			○		
11				○	
12		○			
13			○		
14		○	⊗		
15		⊗	○		

OUTPUT CHECK



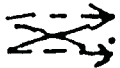

NO.	1 st Step VR 3.1	MODE	5V - 1V _{3W}		Digital Volt Mtr			Measure STEP	Limit	
			A	B	A	B	C			
28	"1" A B C		5V	↑	○			"1"	+4.90 ~ +5.10 V	
29			1V		5V	○			"1"	+0.95 ~ +1.05 V
30							○		"1"	+4.90 ~ +5.10 V
31					↓		○		"1"	+0.95 ~ +1.05 V
32								○	"1"	+4.90 ~ +5.10 V
33							○		"A" "1"	+4.85 ~ +5.15 V
34				5V	5V	○			"B" "1"	+4.85 ~ +5.15 V
35						○			"A" "1"	-4.85 ~ -5.15 V
36		"1" A B C				○			"B" "1"	-4.85 ~ -5.15 V
37						○			"1"	-4.90 ~ -5.10 V
38								○	"1"	-4.90 ~ -5.10 V
39							○	"1"	-0.10 ~ +0.10 V	

○ Digital voltmeter to measure the phone jack

Function Test (3)

No.	Item	Check
16	Portamento-A	Portamento effect should only show up in the channel A output when you turn up this knob.
17.	Portamento-B	Portamento should only show up in the B channel output.
18.	Duty	Should get shorter when knob is turned counter-clockwise. Should get longer when turned clockwise.
19.	Reset, Trig Out (1~11)	Connect RESET ^{TRIG} IN jack to each of TRIG OUT jacks 1 through 11 in turn, and see that the sequence returns to 1 after reaching the proper step. Disconnect after check.
20.	Trig Out (12)	With TRIG OUT 12 connected to the MS-10 TRIG IN jack, see that there is only a sound produced at the 12th step in a sequence. Disconnect after check.
21.	Step (jack)	Set mode to ⊗  . Connect MS-10 momentary switch to STEP jack and see that steps advance when you press the MS-10 switch. Set mode back to ⊗  and disconnect after check.
22.	Start/Stop (jack)	Connect MS-10 momentary switch to S/S jack,

and see that the MS-10 switch will turn the S/S on and off.
Disconnect after check.

23. Linear In Connect MS-10 control wheel  out to
 LINEAR IN jack, and see that the clock
 speed changes with input voltage. It should
 get faster toward +5V. Disconnect after check.
24. x2/V Connect MS-10  out to x2/V jack, and see
 that clock speed changes with input voltage.
 Speed increases towards +5V. Disconnect
 after check.
25. +2/V Connect MS-10  out to +2/V jack, and see
 that clock speed changes with input voltage.
 Speed should decrease toward +5V. Disconnect
 after check.
26. Clock Turning the CLOCK knob all the way counter-
 clockwise should slow down the cycle 10sec ~ 40sec.
 Turning the knob clockwise should speed up the
 clock.
27. Analog The sum of IN 1 and IN 2 voltages should
 Mixer appear in the OUT voltage.
 For example: Connect MS-10  out to IN 1;
 Connect SQ-10 multiple trigger out to IN 2;
 Connect MS-10 CV IN to OUT.

Multiple trigger signal should modulate pitch of note
when keyboard is played (or momentary switch is pressed)
on MS-10. Changing IN 1 input voltage (from control wheel)
will vary entire pitch.

FREQ CV IN

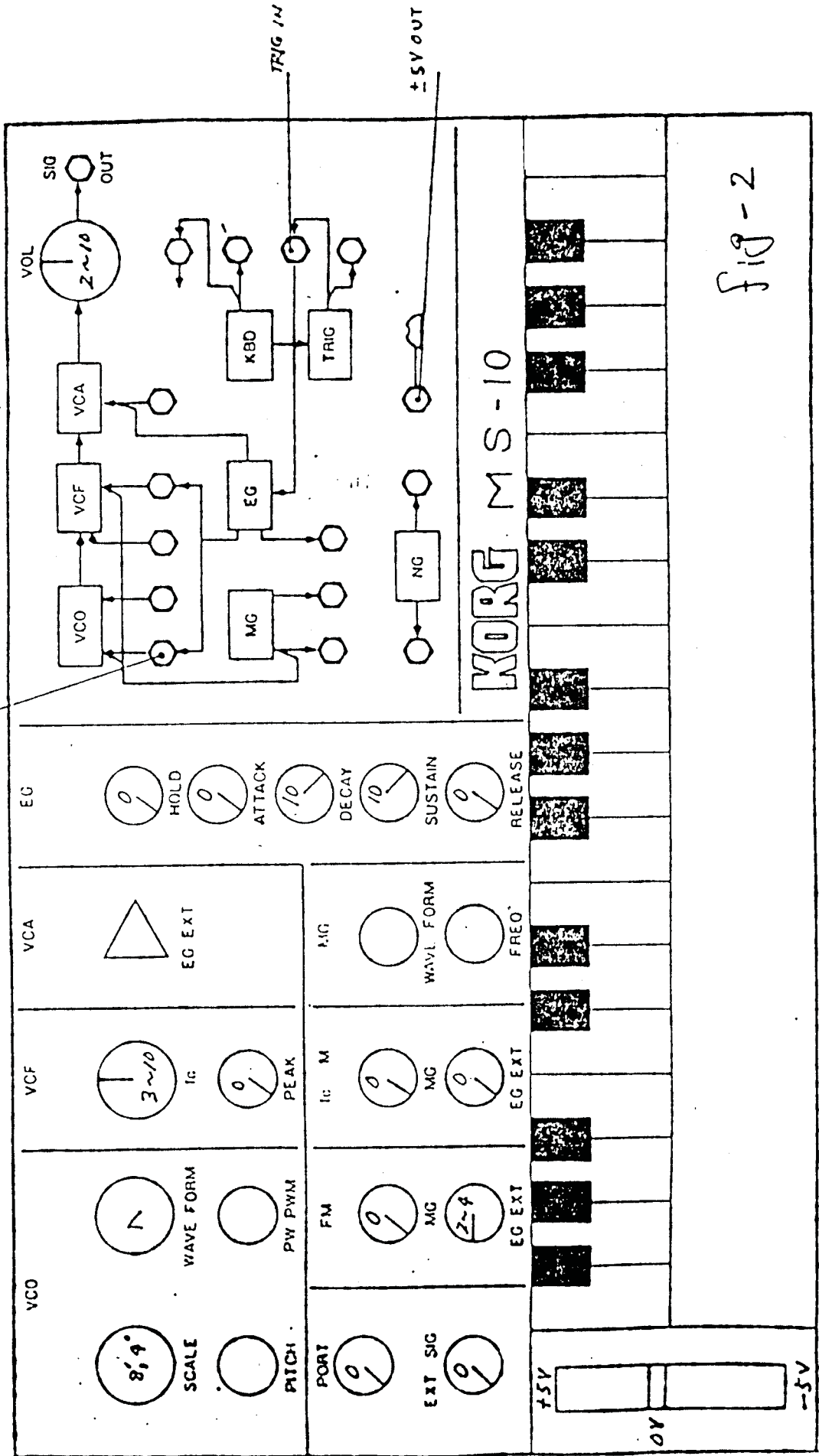
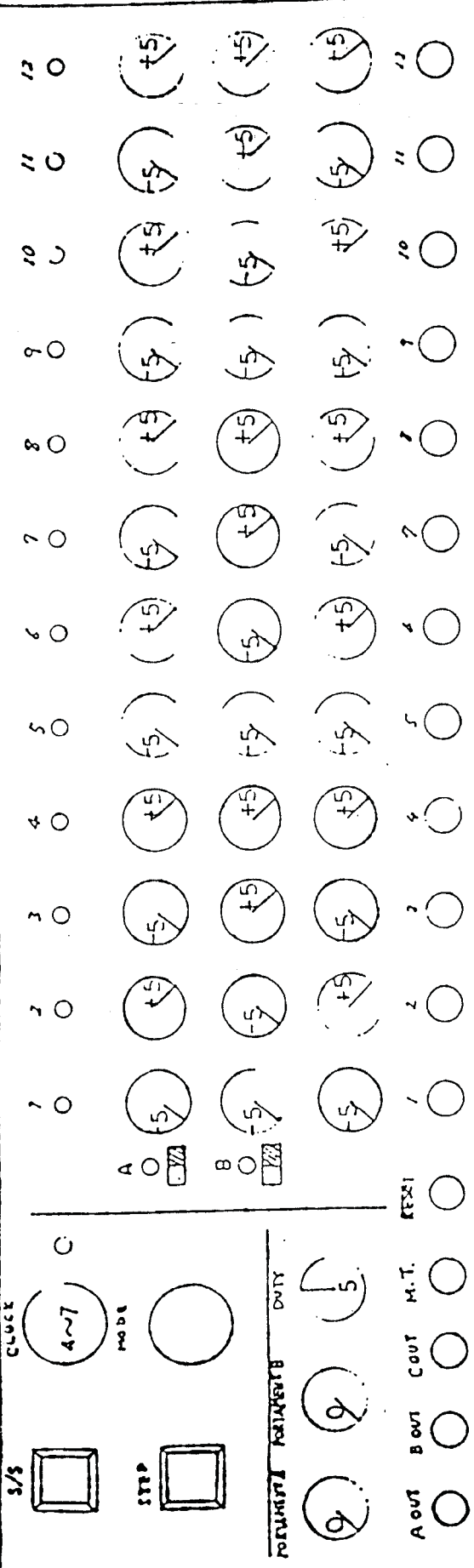
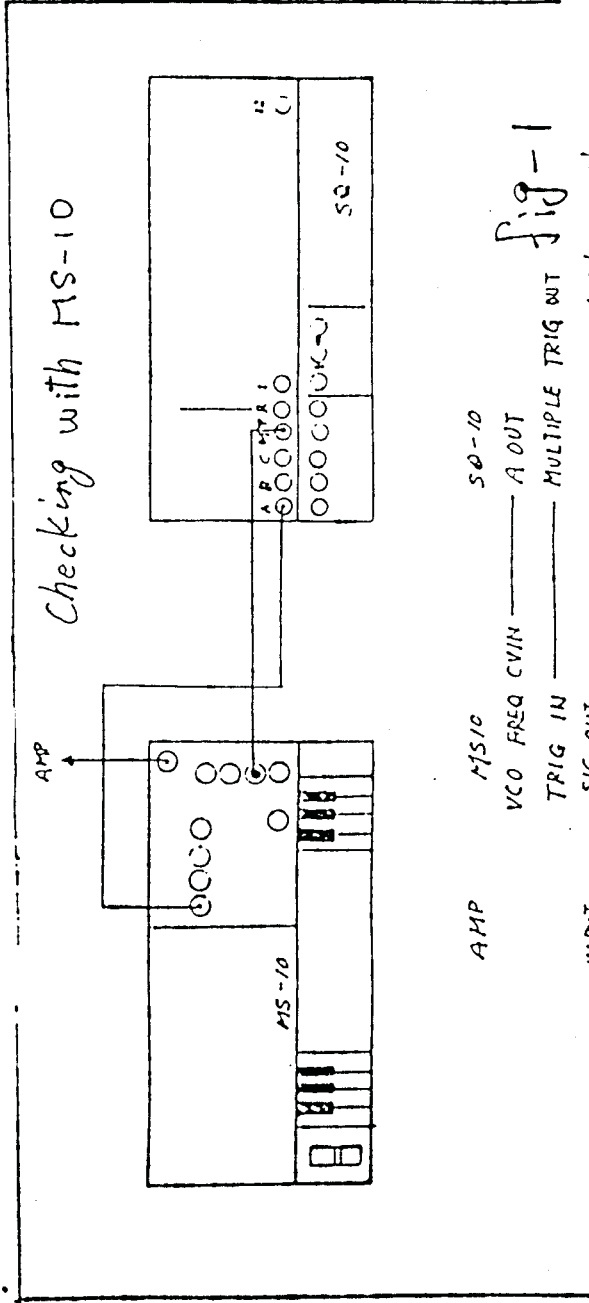

FIG-2



KORG ANALOG SEQUENCER

fig-3



Checking with MS-10

AMP MS-10 SQ-10
 VCO FREQ CVIN A OUT
 TRIG IN MULTIPLE TRIG OUT
 INPUT SIG OUT
 See other chart for MS-10 control settings

fig-1

452

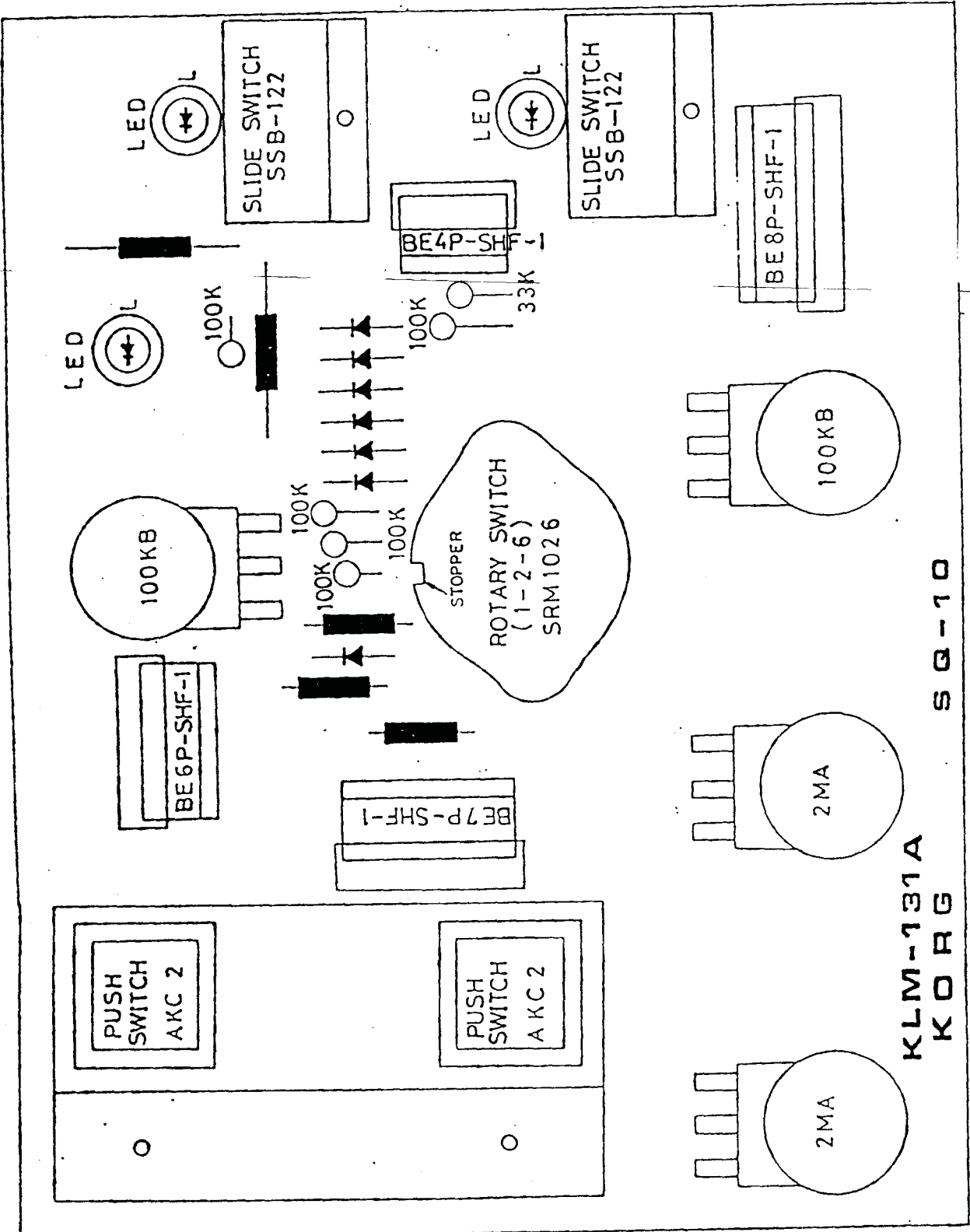

SQ 10 KLM-132C

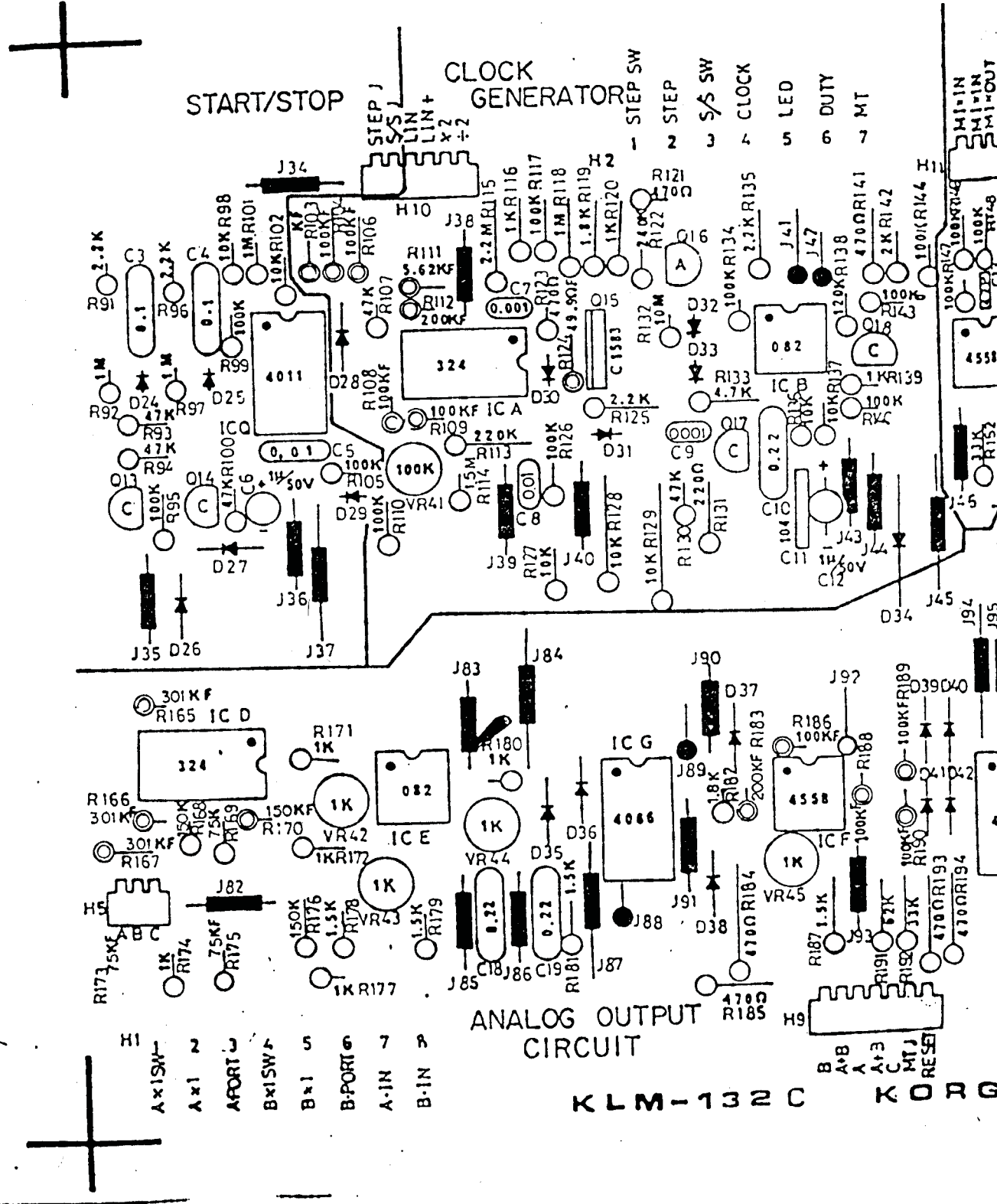

KLM-132C K O P G

3010 KLM-133A

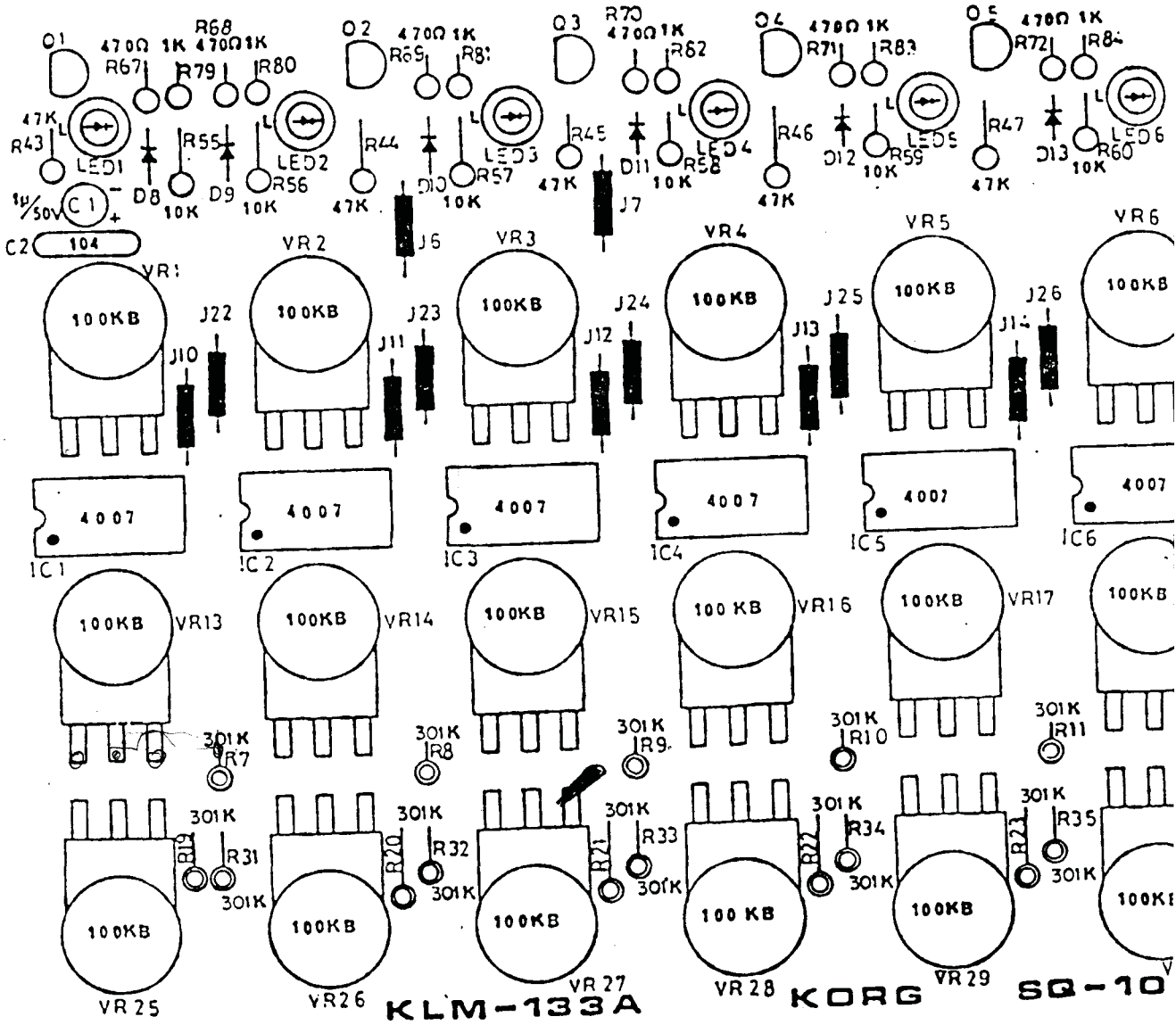

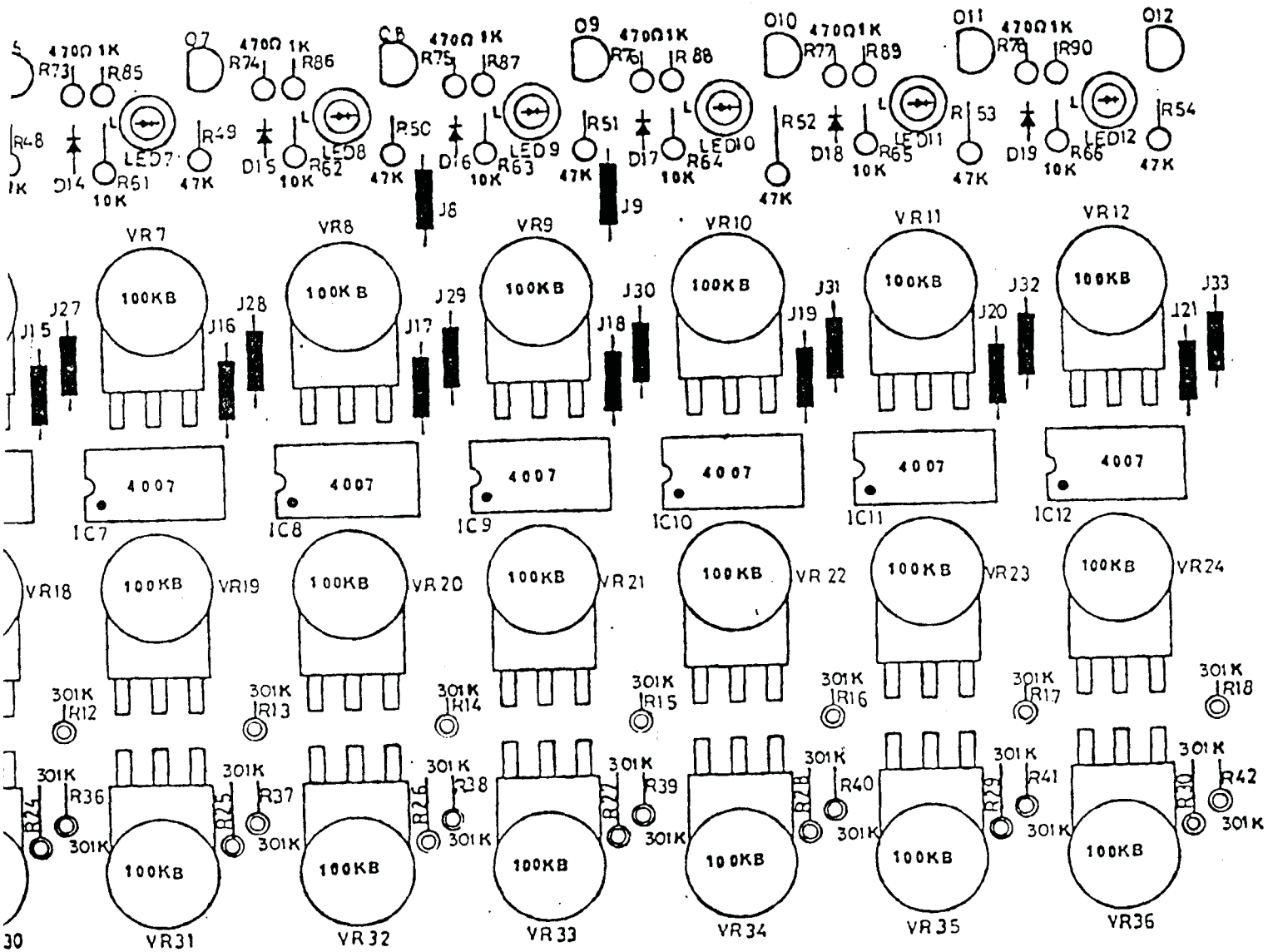

⑤ = 50-16P5

50-10		KLM-133A	
KOD-F10004		京王技研工業株式会社	

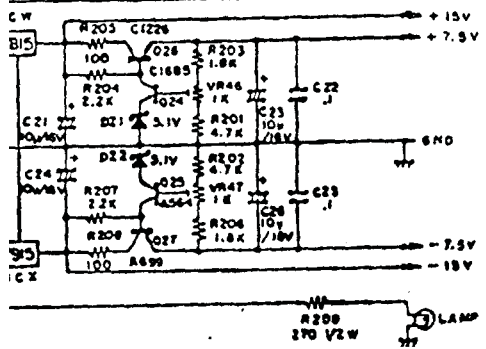
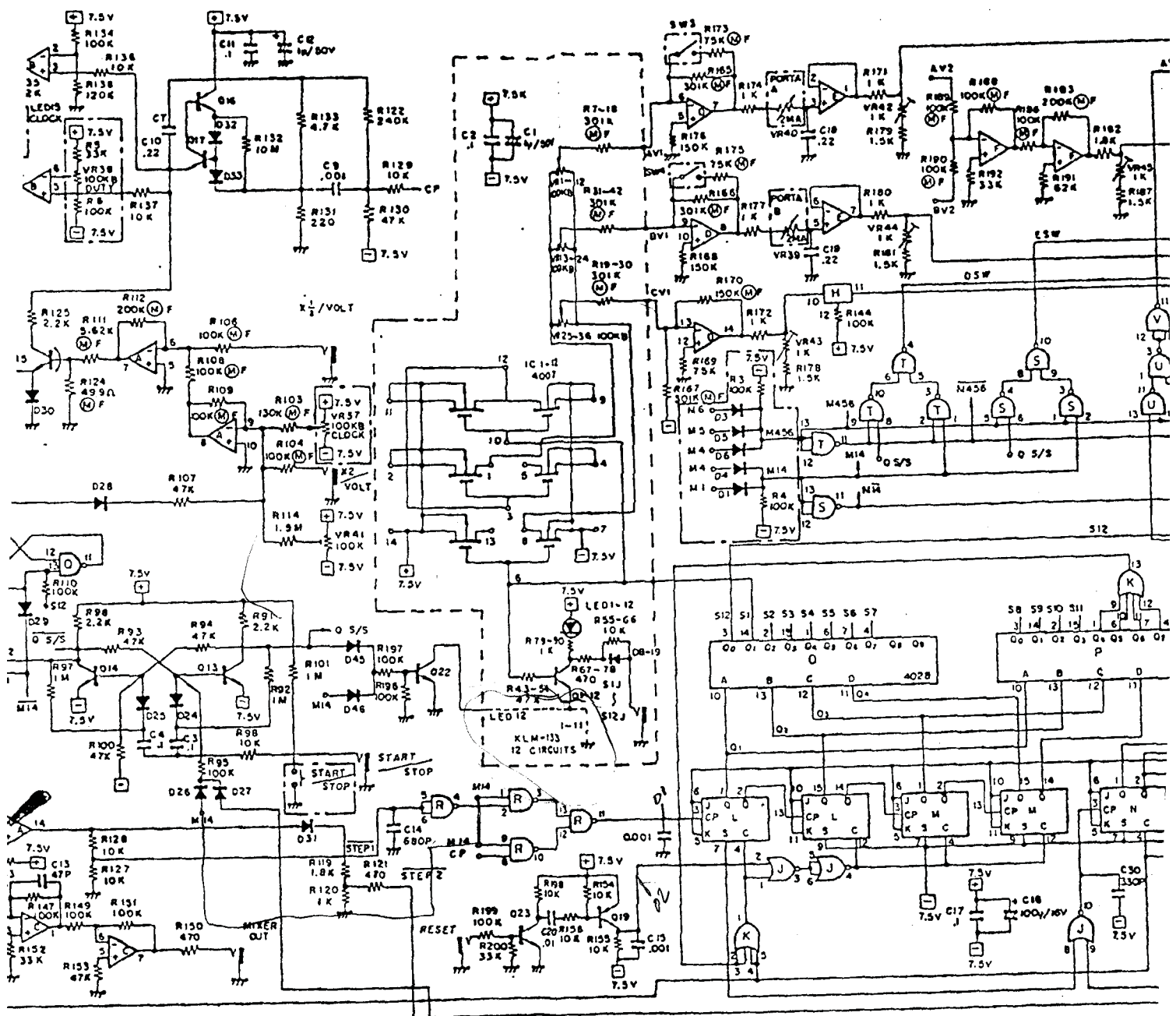

KLM132: MAIN CIRCUIT BOARD
 KLM133: SEQUENCE CIRCUIT BOARD
 KLM131: CONTROL CIRCUIT BOARD

* 2SA564 PNP
 * 2SC1683 NPN
 OP Amp : 2.5V
 ANALOG SW : 7.5V
 DIGITAL IC : 2.5V

IC	CHART	NO.	OP	CHNS
A	34	1		
B	022	2		
C	038	3		
D	021	4		
E	021	5		
F	038	6		
G	066	7		
H	066	8		
I	001	9		
J	022	10		
K	027	11		
L	027	12		
M	027	13		
N	028	14		
O	028	15		
P	011	16		
Q	011	17		
R	011	18		
S	011	19		
T	011	20		
U	011	21		
V	011	22		
W	011	23		
X	011	24		
Y	011	25		
Z	011	26		
AA	011	27		
AB	011	28		
AC	011	29		
AD	011	30		
AE	011	31		
AF	011	32		
AG	011	33		
AH	011	34		
AI	011	35		
AJ	011	36		
AK	011	37		
AL	011	38		
AM	011	39		
AN	011	40		
AO	011	41		
AP	011	42		
AQ	011	43		
AR	011	44		
AS	011	45		
AT	011	46		
AU	011	47		
AV	011	48		
AW	011	49		
AX	011	50		
AY	011	51		
AZ	011	52		
BA	011	53		
BB	011	54		
BC	011	55		
BD	011	56		
BE	011	57		
BF	011	58		
BG	011	59		
BH	011	60		
BI	011	61		
BJ	011	62		
BK	011	63		
BL	011	64		
BM	011	65		
BN	011	66		
BO	011	67		
BP	011	68		
BQ	011	69		
BR	011	70		
BS	011	71		
BT	011	72		
BU	011	73		
BV	011	74		
BW	011	75		
BX	011	76		
BY	011	77		
BZ	011	78		
CA	011	79		
CB	011	80		
CC	011	81		
CD	011	82		
CE	011	83		
CF	011	84		
CG	011	85		
CH	011	86		
CI	011	87		
CJ	011	88		
CK	011	89		
CL	011	90		
CM	011	91		
CN	011	92		
CO	011	93		
CP	011	94		
CQ	011	95		
CR	011	96		
CS	011	97		
CT	011	98		
CU	011	99		
CV	011	100		
CW	011	101		
CX	011	102		
CY	011	103		
CZ	011	104		
DA	011	105		
DB	011	106		
DC	011	107		
DD	011	108		
DE	011	109		
DF	011	110		
DG	011	111		
DH	011	112		
DI	011	113		
DJ	011	114		
DK	011	115		
DL	011	116		
DM	011	117		
DN	011	118		
DO	011	119		
DP	011	120		
DQ	011	121		
DR	011	122		
DS	011	123		
DT	011	124		
DU	011	125		
DV	011	126		
DW	011	127		
DX	011	128		
DY	011	129		
DZ	011	130		
EA	011	131		
EB	011	132		
EC	011	133		
ED	011	134		
EE	011	135		
EF	011	136		
EG	011	137		
EH	011	138		
EI	011	139		
EJ	011	140		
EK	011	141		
EL	011	142		
EM	011	143		
EN	011	144		
EO	011	145		
EP	011	146		
EQ	011	147		
ER	011	148		
ES	011	149		
ET	011	150		
EU	011	151		
EV	011	152		
EW	011	153		
EX	011	154		
EY	011	155		
EZ	011	156		
FA	011	157		
FB	011	158		
FC	011	159		
FD	011	160		
FE	011	161		
FF	011	162		
FG	011	163		
FH	011	164		
FI	011	165		
FJ	011	166		
FK	011	167		
FL	011	168		
FM	011	169		
FN	011	170		
FO	011	171		
FP	011	172		
FO	011	173		
FQ	011	174		
FR	011	175		
FS	011	176		
FT	011	177		
FU	011	178		
FV	011	179		
FW	011	180		
FX	011	181		
FY	011	182		
FZ	011	183		
GA	011	184		
GB	011	185		
GC	011	186		
GD	011	187		
GE	011	188		
GF	011	189		
GG	011	190		
GH	011	191		
GI	011	192		
GJ	011	193		
GK	011	194		
GL	011	195		
GM	011	196		
GN	011	197		
GO	011	198		
GP	011	199		
GQ	011	200		
GR	011	201		
GS	011	202		
GT	011	203		
GU	011	204		
GV	011	205		
GW	011	206		
GX	011	207		
GY	011	208		
GA	011	209		
GB	011	210		
GC	011	211		
GD	011	212		
GE	011	213		
GF	011	214		
GG	011	215		
GH	011	216		
GI	011	217		
GJ	011	218		
GK	011	219		
GL	011	220		
GM	011	221		
GN	011	222		
GO	011	223		
GP	011	224		
GQ	011	225		
GR	011	226		
GS	011	227		
GT	011	228		
GU	011	229		
GV	011	230		
GW	011	231		
GX	011	232		
GY	011	233		
GA	011	234		
GB	011	235		
GC	011	236		
GD	011	237		
GE	011	238		
GF	011	239		
GG	011	240		
GH	011	241		
GI	011	242		
GJ	011	243		
GK	011	244		
GL	011	245		
GM	011	246		
GN	011	247		
GO	011	248		
GP	011	249		
GQ	011	250		
GR	011	251		
GS	011	252		
GT	011	253		
GU	011	254		
GV	011	255		
GW	011	256		
GX	011	257		
GY	011	258		
GA	011	259		
GB	011	260		
GC	011	261		
GD	011	262		
GE	011	263		
GF	011	264		
GG	011	265		
GH	011	266		
GI	011	267		
GJ	011	268		
GK	011	269		
GL	011	270		
GM	011	271		
GN	011	272		
GO	011	273		
GP	011	274		
GQ	011	275		
GR	011	276		
GS	011	277		
GT	011	278		
GU	011	279		
GV	011	280		
GW	011	281		
GX	011	282		
GY	011	283		
GA	011	284		
GB	011	285		
GC	011	286		
GD	011	287		
GE	011	288		
GF	011	289		
GG	011	290		
GH	011	291		
GI	011	292		
GJ	011	293		
GK	011	294		
GL	011	295		
GM	011	296		
GN	011	297		
GO	011	298		
GP	011	299		
GQ	011	300		

